

# PHILIPS

## CertaDrive

### LED driver



## Datasheet

### CertaDrive G2

CertaDrive 8W 0.2A 42V I 230V

#### Affordable and reliable LED Drivers

Affordable LED Driver range offering Philips reliability. The CertaDrive range is compatible with COB and mid-power LEDs from any LED manufacturer.

#### Benefits

- Driver design based on Philips experience and knowledge of conventional fluorescent and HID technologies
- Various power wattage Drivers that are related to the lumen packages/applications
- Fixed output Drivers
- Independent-version housing design for stand-alone installations

#### Features

- High reliability
- Luminaire design flexibility to keep stable/constant
- Lumen output and light quality levels
- Fast Time to Market
- One supplier for professional general lighting LED Drivers
- Affordable LED Drivers

#### Application

- Public buildings (airports, cinemas, theaters, exhibition halls)
- Retail (supermarkets, shops)
- Office

## Electrical input data

Specification item	Value	Unit	Condition
Rated input voltage range	220...240	V <sub>ac</sub>	Performance range
Rated input voltage	230	V <sub>ac</sub>	
Rated input frequency range	50...60	Hz	Performance range
Rated input current	0.05	A	@ rated output power @ rated input voltage
Rated input power	10.5	W	@ rated output power @ rated input voltage
Power factor	≥ 0.9		@ rated output power @ rated input voltage
Total harmonic distortion	≤ 20	%	@ rated output power @ rated input voltage
Efficiency	≥ 80	%	@ rated output power @ rated input voltage
Input voltage AC range	198...254	V <sub>ac</sub>	Operational range
Input frequency AC range	47.5...63	Hz	Operational range
Isolation input to output	SELV		

## Electrical output data

Specification item	Value	Unit	Condition
Regulation method	Constant Current		
Output voltage	30...42	V <sub>dc</sub>	
Output voltage max.	60	V	Peak voltage at open load
Output current	0.2	A	Full output current setting
Output current tolerance	± 8	%	
Output current ripple LF	≤ 30	%	Ripple = peak / average
Output power	6...8.4	W	Full output

## Electrical data controls input

Specification item	Value	Unit	Condition
Control method	Fixed		

## Logistical data

Specification item	Value
Product name	CertaDrive 8W 0.2A 42V I 230V
Logistic code 12NC	9290 014 21780
Pieces per box	48

## Wiring & Connections

Specification item	Value	Unit	Condition
Input wire cross-section	0.75...1.5	mm <sup>2</sup>	Connector250 (3.5 mm), solid / stranded wire
	16...21	AWG	Connector250 (3.5 mm), solid / stranded wire
Input wire strip length	8.5...9.5	mm	
Output wire cross-section	0.75...1.5	mm <sup>2</sup>	Connector250 (3.5 mm), solid / stranded wire
	16...21	AWG	Connector250 (3.5 mm), solid / stranded wire
Output wire strip length	8.5...9.5	mm	
Maximum cable length	600	mm	Total length of wiring including LED module, one way

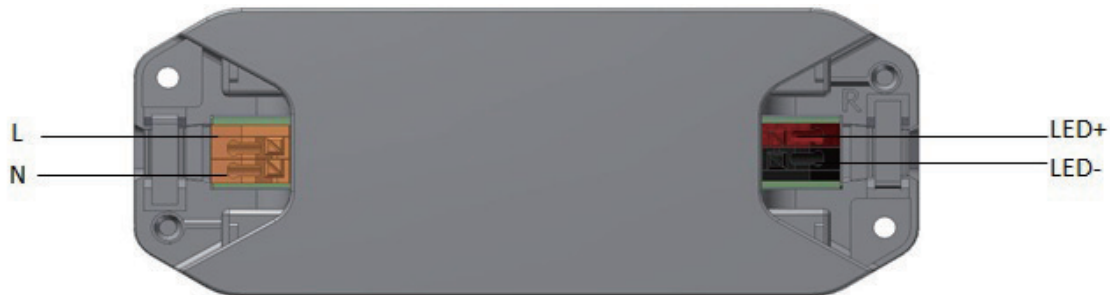

## Dimensions and weight

Specification item	Value	Unit	Condition
Length (A1)	115	mm	
Width (B1)	45	mm	
Height (C1)	29	mm	
Fixing hole diameter (D1)	3.4	mm	
Fixing hole distance (A2)	105	mm	
Weight	70	gram	

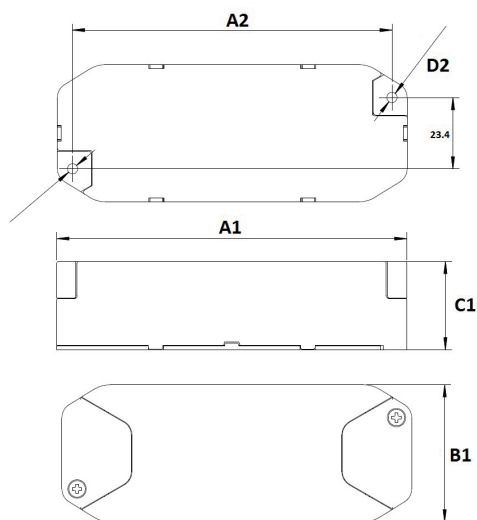

## Operational temperatures and humidity

Specification item	Value	Unit	Condition
Ambient temperature	-20...+50	°C	Higher ambient temperature allowed as long as T <sub>case-max</sub> is not exceeded.
T <sub>case-max</sub>	75	°C	Maximum temperature measured at T <sub>case-point</sub>
T <sub>case-life</sub>	65	°C	Measured at T <sub>case-point</sub>
Maximum housing temperature	110	°C	In case of a failure
Relative humidity	10...90	%	Non-condensing

## Storage temperature and humidity

Specification item	Value	Unit	Condition
Ambient temperature	-25...+85	°C	
Relative humidity	5...95	%	Non-condensing

## Lifetime

Specification item	Value	Unit	Condition
Driver lifetime	30,000	hours	Measured temperature at T <sub>case-point</sub> is T <sub>case-life</sub> . Maximum failures = 10%

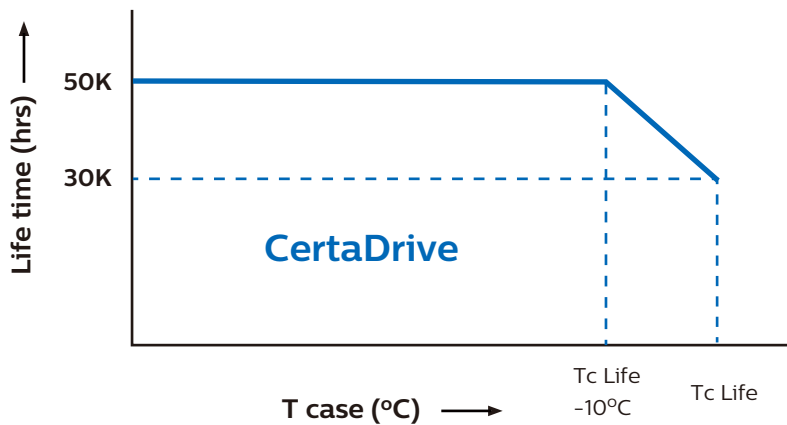

## Programmable features

Specification item	Value	Remark	Condition
Set output current (AOC)		See Design-in guide.	Default output current: = 200 mA
LED module temperature derating (MTP)	No		
Driver Temperature Limit (DTL)	No		
Constant Lumen Over Lifetime (CLO)	No		
DC emergency dimming (DCemDIM)	No		
Corridor mode	No		
Energy metering	No		
Diagnostics	No		

## Features

Specification item	Value	Remark	Condition
Open load protection	Yes		Automatic recovering
Short circuit protection	Yes		Automatic recovering
Over power protection	Yes		Automatic recovering
Hot wiring	No		
Suitable for fixtures with protection class	II		per IEC60598

## Certificates and standards

Specification item	Value
Approval marks	CCC / CE / ENEC / F-mark / RCM / TISI
Ingress Protection classification	20

## Inrush current

Specification item	Value	Unit	Condition
Inrush current $I_{peak}$	4.8	A	Input voltage 230V
Inrush current $T_{width}$	60	$\mu s$	Input voltage 230V, measured at 50% $I_{peak}$
Drivers / MCB 16A type B	$\leq 40$	pcs	

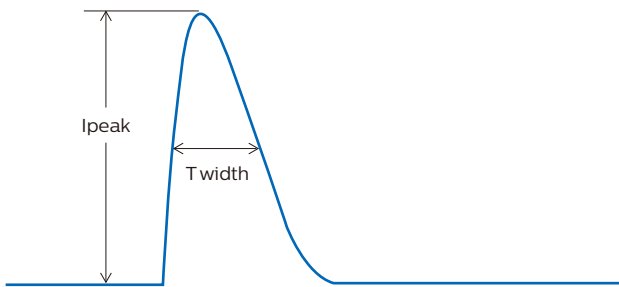

MCB	Rating	Relative number of LED drivers
B	10A	63%
B	13A	81%
B	16A	100% (stated in datasheet)
B	20A	125%
B	25A	156%
C	10A	104%
C	13A	135%
C	16A	170%
C	20A	208%
C	25A	260%

## Driver touch current / protective conductor current

Specification item	Value	Unit	Condition
Typical touch current (ins. Class II)	< 0.7	mA peak	Acc. IEC61347-1. LED module contribution not included

## Surge immunity

Specification item	Value	Unit	Condition
Mains surge immunity (diff. mode)	0.5	kV	Acc. IEC61000-4-5. 2 Ohm, 1.2/50us, 8/20us
Mains surge immunity (comm. mode)	1	kV	Acc. IEC61000-4-5. 12 Ohm, 1.2/50us, 8/20us

## Graphs

### Operating window

---

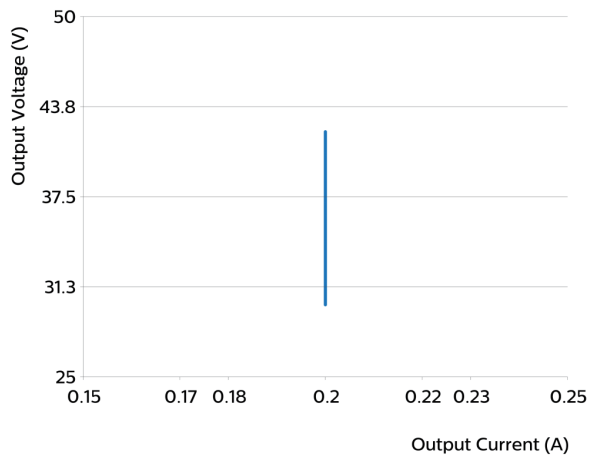

### Power factor versus output power

---

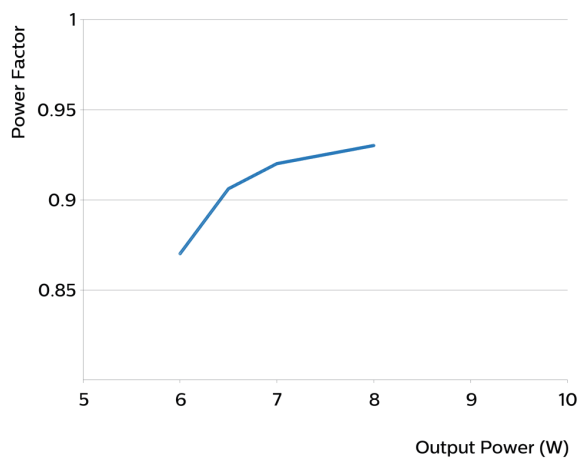

### Efficiency versus output power

---

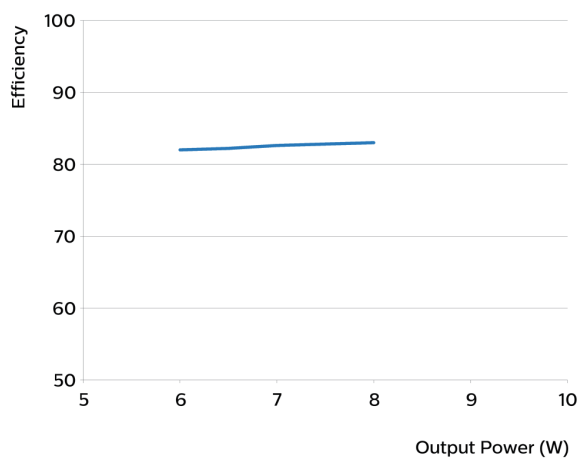

## THD versus output power

---

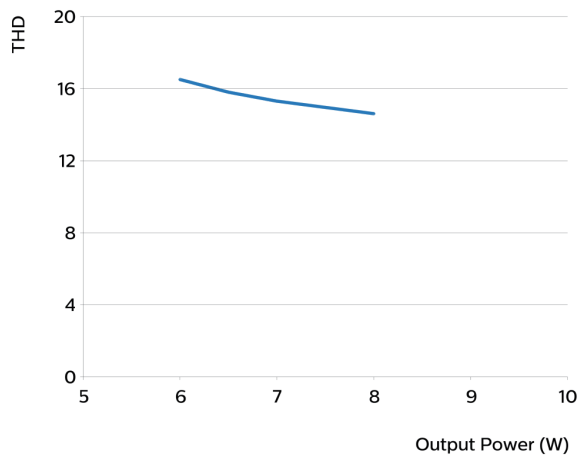

©2017 Philips Lighting Holding B.V. All rights reserved.

This document contains information relating to the Philips Lighting portfolio, intended for companies who may be interested in developing their product offering. Note that the information provided is subject to change. Philips Lighting does not give any representation or warranty as to the accuracy or completeness of the information included herein and shall not be liable for any action in reliance thereon. The information presented in this document is not intended as any commercial offer and does not form part of any quotation or contract.

Date of release: November 23, 2017 v3

[www.philips.com/technology](http://www.philips.com/technology)